

40 MB Business Card Disc Label

Die# 22-40MB BC

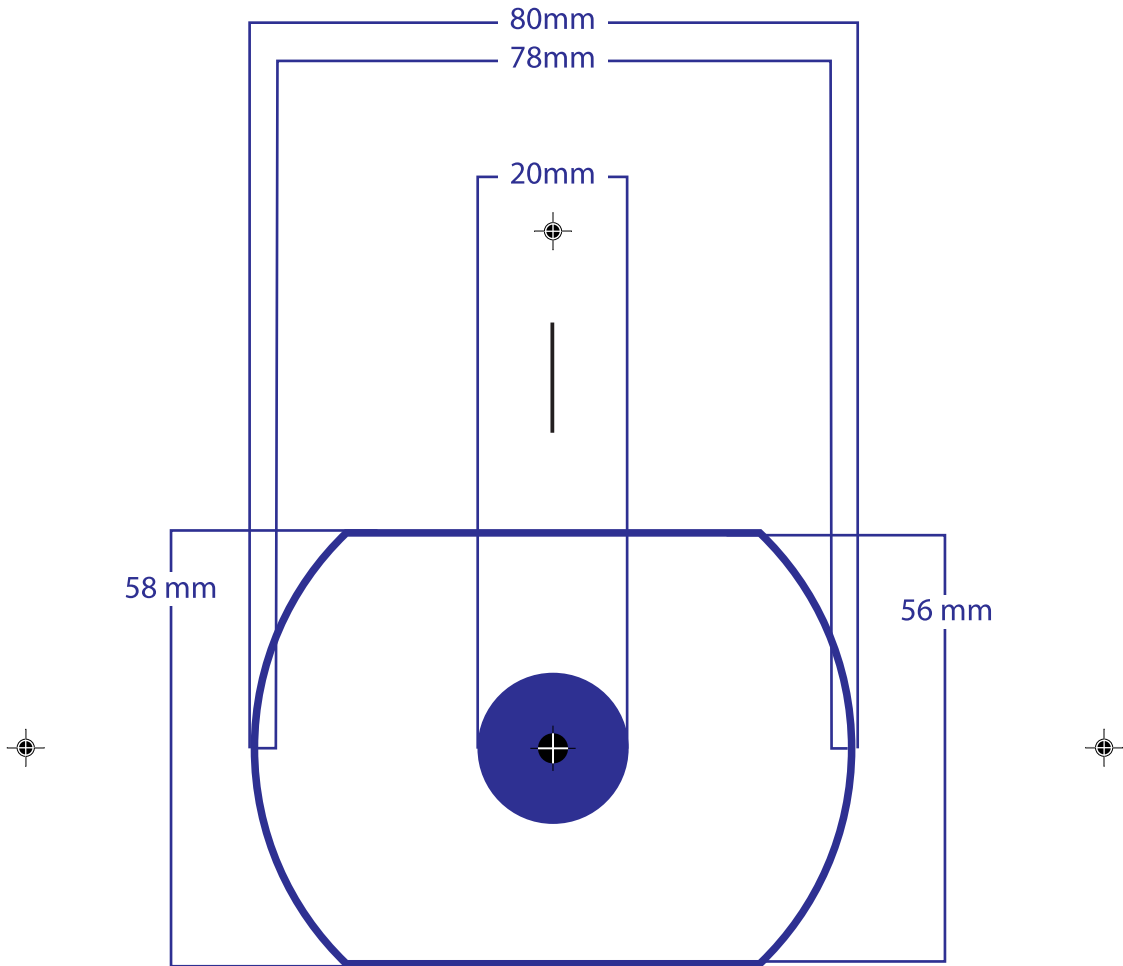

Ink Colors Used:

- Pantone 1st
- Pantone 2nd
- Pantone 3rd
- Pantone 4th
- Pantone 5th

Used for specific colors. Don't use for 4-color process
For optimal color, a white flood coat is generally required

Disc Label Specifications

CD Size	58 X 80 mm
Printable Area	56 X 78 mm
Center no print	20 mm

- All fonts and images must be included with the art file and saved on disk or converted to outlines. Embedding images and fonts is recommended.
- Artwork may bleed outside blue no-print areas if being sent electronically, however, no art may appear outside the printable area or over the center hole (blue areas) when film is developed. Make a "Clipping Mask" to eliminate artwork that falls outside the print area.
- Resolution of film output should be 1200X2400 and 100 lpi for Pantone colors or 133 lpi for process. Offset printing resolution should be 185 lpi.
- Film for silk screen is positive, emulsion side up, right reading.
- Film for offset is negative, emulsion down, right reading.
- Keep all registration marks and color keys.
- To ensure accurate color matching, provide a hard copy color proof with this file.